

100mW Ultra small size
Long-distance wireless transceiver module

Product Specification



RF4463PRO-868



RF4463PRO-915

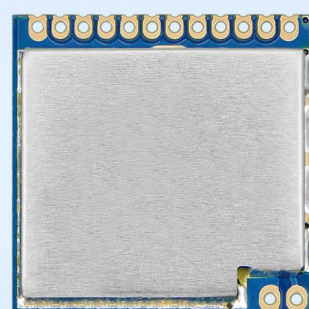

RF4463PRO

Catalogue

1. Overview.....	- 3 -
2. Features.....	- 3 -
3. Application.....	- 4 -
3. Electrical Characteristics.....	- 4 -
4. Typical application circuit.....	- 5 -
5. Pin definition.....	- 5 -
6. Communication Antenna.....	- 6 -
7. Mechanical size (unit: mm).....	- 7 -
9. Product order information.....	- 7 -
10. Common problem.....	- 8 -
Appendix 1:SMD Reflow Chart.....	- 8 -
Appendix 2:Demo Board.....	- 9 -

Note: Revision History

Revision	Date	Comment
V1.0	2015-10-16	First release
V2.0	2016-8-5	Typesetting changes
V2.1	2017-6	Frequency parameter changes
V2.2	2018-12-13	Pin description changes
V2.3	2019-7-3	Cover update
V3.0	2020-11	Change part of the description

1. Overview

Our company's RF4463PRO module uses Silicon Lab si4463 chip, which is a highly integrated wireless ISM band transceiver chip. It has extremely low receiving sensitivity (-126 dBm), coupled with the industry-leading output power of +20 dBm, ensures extended range and improved link performance.

RF4463PRO uses lead-free technology for production and testing strictly. It also meets RoHS and Reach standards.

RF4463PRO-433 and RF4463PRO-868 modules have obtained CE certification, RF4463PRO-433 and RF4463PRO-915 have obtained FCC certification, and RF4463PRO-915 has also obtained IC certification.

Module type	Working frequency (customizable 142-1050MHz)	Certification
RF4463PRO-433	Center 433MHz	Have CE and FCC certified versions
RF4463PRO-490	Center 490MHz	No
RF4463PRO-868	Center 868MHz	Have a version of CE
RF4463PRO-915	Center 915MHz	Have CE and FCC certified versions

2. Features

- Frequency Range: 433/490/868/915 (customizable 142-1050MHz)
- Sensitivity up to -126dBm
- Maximum output power: 20dBm
- 10mA@Receiving status
- Data transfer rate: 0.1-1000Kbps
- (G)FSK, 4(G)FSK, (G)MSK
- OOK and ASK Modulation mode
- 1.8-3.6 V Power supply
- Ultra-low consumption shutdown mode
- Digital received signal strength indicator(RSSI)
- Timed wake-up function
- Antenna automatic matching and two-way switch control
- Configurable data packet structure
- Preamble detection
- 64/128byte transmit and receive data register (FiFo)
- Low-battery detection
- Temperature sensor and 8-bit analog-to-digital converters
- weight: 1.3 g
- Operating Temperature Range: -40 ~ +85°C
- Integrated voltage regulator
- Frequency hopping
- Power-on reset function
- Built-in crystal adjustment function

3. Application

- Remote control
- Remote meter reading
- Home security alarm
- Industrial control
- Home automation remote sensing
- Individual data records
- Toys control
- Sensor network
- Tire pressure monitoring
- Health monitoring
- Wireless PC peripherals
- Tag reading and writing

3. Electrical Characteristics

Parameter	Min	Typ	Max	Unit	Condition
Working Condition					
Working voltage range	1.8	3.3	3.6	V	
Temperature voltage	-40		85	°C	
Current Consumption					
Receiving current		13.5		mA	High performance mode
Receiving current		10.7		mA	Low power mode
Transmitting current		85		mA	@20dBm
Sleep current		< 0.1		uA	
RF Parameter					
Frequency range	403	433	463	MHz	@433MHz
	470	490	510	MHz	@490MHz
	820	868	880	MHz	@868MHz, 19dBm
	900	915	930	MHz	@915MHz, 18.5dBm
Modulation rate	0.123		1000	Kbps	FSK
Output power range	-5		20	dBm	
Receiving sensitivity		-126		dBm	@Data rate=500bps

4. Typical application circuit

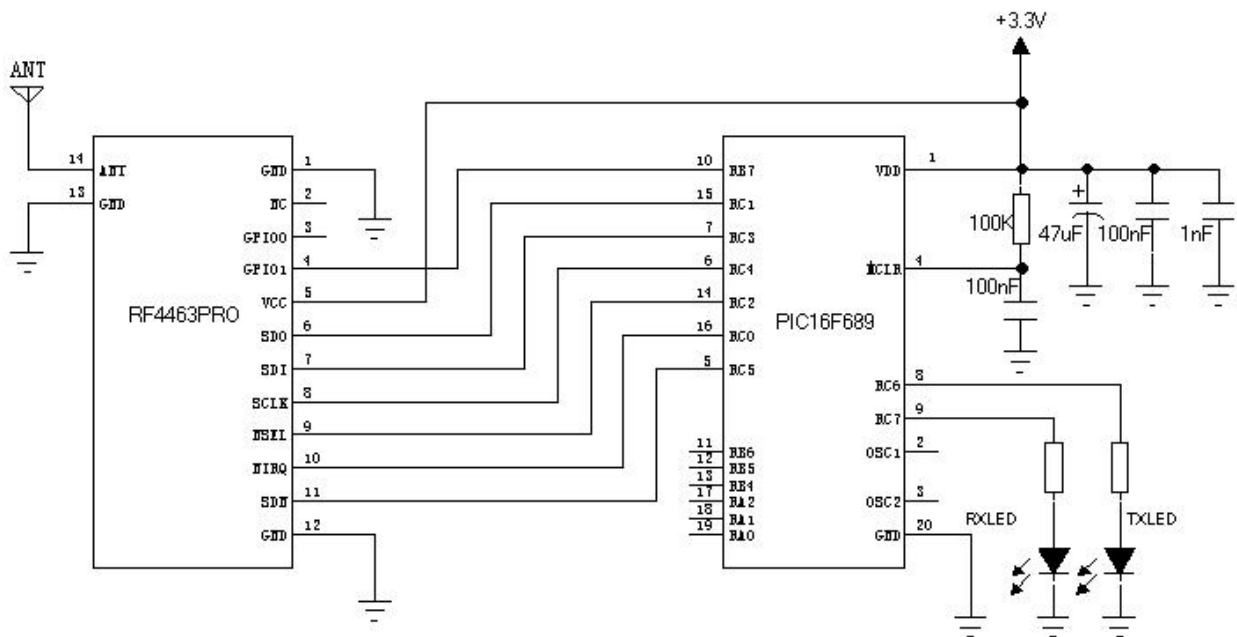

5. Pin definition

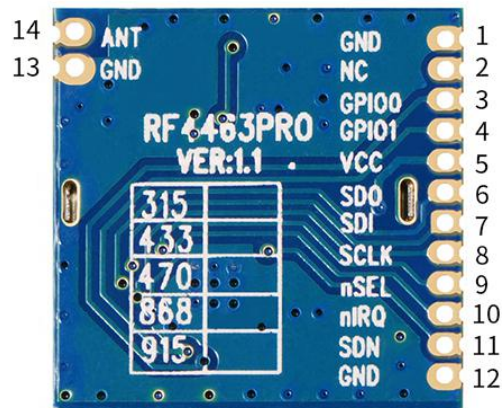
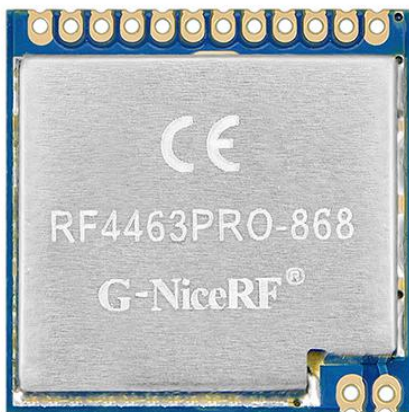

Note: The GPIO2 and GPIO3 pins of the chip are directly connected to the antenna switch inside the module. GPIO2 controls receiving, GPIO3 controls transmitting.

Pin NO.	Pin name	Description
1	GND	Power ground
2	NC	NC
3	GPIO0	Connect directly to the GPIO0 pin of the chip
4	GPIO1	Connect directly to the GPIO1 pin of the chip

5	VCC	Positive power supply 3.3V
6	SDO	0 ~ VDD V digital output, provides serial readback function to internal control register
7	SDI	Serial data input. 0 ~ VDD V digital input. This pin is a 4-wire serial data stream bus.
8	SCLK	Serial clock input. 0 ~ VDD V digital input. This pin provides a 4-wire serial data clock function.
9	nSEL	Serial interface select input pin. 0 ~ VDD V digital input. This pin provides select/enable function for 4-wire serial data bus. This signal is also used to indicate burst read/write mode.
10	nIRQ	Interrupt output
11	SDN	Chip enable pin. 0 ~ VDD V digital input. SDN=0 in all modes except shutdown mode. When SDN=1, the chip will be completely shut down and the contents of the register will be lost.
12	GND	Power ground
13	GND	Power ground
14	ANT	Connect with 50 ohm coaxial antenna

6. Communication Antenna

Antenna is very important for RF communication, its performance will affect the communication directly. Module needs antenna in 50ohm.SMA can also be used to transfer straight/elbow/folded rod. Users can order accordingly. To ensure module in the best performance, we suggest to use the our antenna.

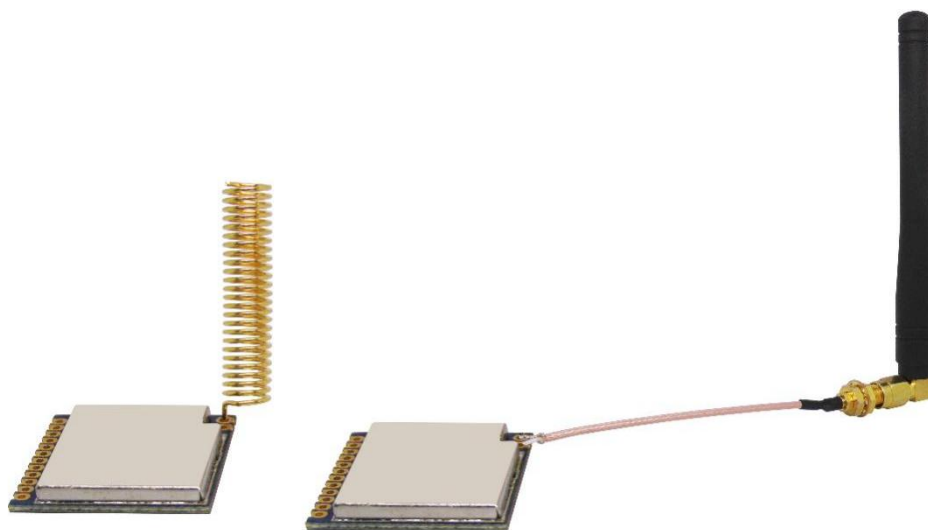

★To ensure modules get the best performance, user must obey the following principles when using the antennas:

- Put the antenna away from the ground and obstacles as possible as you could;
- If you choose the sucker antenna, pull straight the lead wire as possible as it can be, the sucker under arches should be attached on the metal object.

7. Mechanical size (unit: mm)

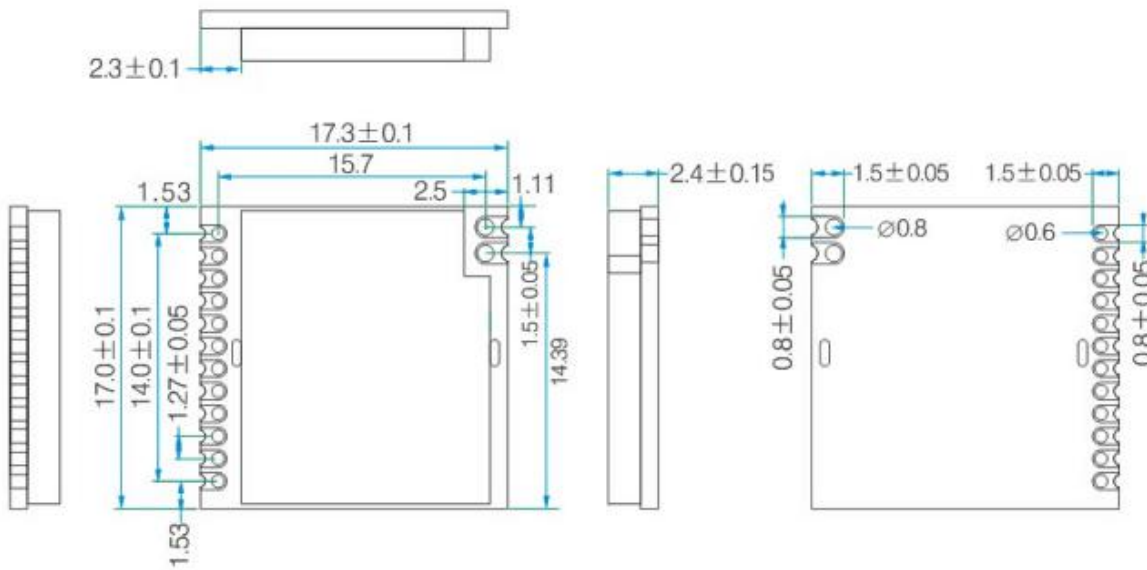

9. Product order information

Order model	product type
RF4463PRO-433	The working center frequency band of the module is 433MHz
RF4463PRO-433-CE	The working center frequency band of the module is 433MHz,CE certified version
RF4463PRO-433-FCC	The working center frequency band of the module is 433MHz,CE certified version
RF4463PRO-490	The working center frequency band of the module is 490MHz
RF4463PRO-868	The working center frequency band of the module is 868MHz
RF4463PRO-868-CE	The working center frequency band of the module is 868MHz,CE certified version
RF4463PRO-915	The working center frequency band of the module is 915MHz,has passed FCC and IC

For example: If the customer needs 433MHz Frequency, The order model is: RF4463PRO-43.

10. Common problem

- a) Why can't the normal communication between the modules?
 - 1) The power connection is wrong and the module is not working normally;
 - 2) Check whether the frequency bands of each module and other RF parameters are consistent;
 - 3) Whether the module is damaged.
- b) Why transmission distance is not far as it should be?
 - 1) Power supply ripple is too large;
 - 2) The antenna types do not match, or not properly installed;
 - 3) The surrounding environment is harsh, strong interference sources;
 - 4) Surrounding co-channel interference;

Appendix 1:SMD Reflow Chart

We recommend you should obey the IPC related standards in setting the reflow profile:

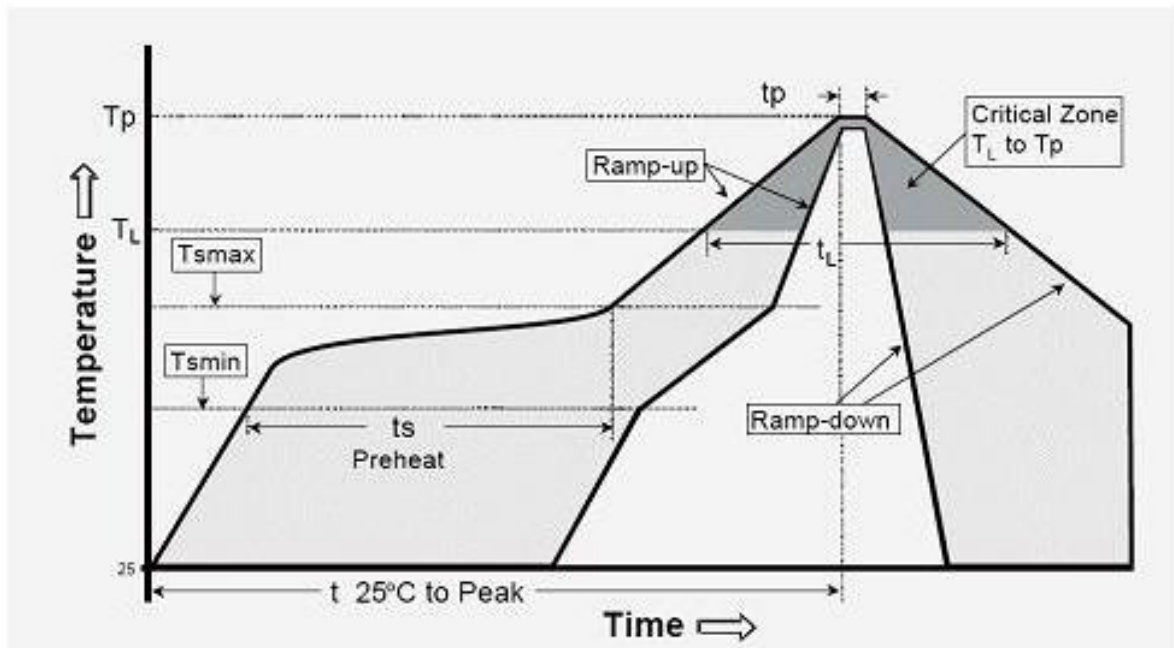

IPC/JEDEC J-STD-020B the condition for lead-free reflow soldering	big size components (thickness $\geq 2.5\text{mm}$)
The ramp-up rate (Tl to Tp)	3°C/s (max.)
preheat temperature	
- Temperature minimum (T _{min})	150°C
- Temperature maximum (T _{max})	200°C
- preheat time (t _s)	60~180s
Average ramp-up rate(T _{max} to Tp)	3°C/s (Max.)
- Liquidous temperature(T _L)	217°C
- Time at liquidous(t _L)	60~150 second
peak temperature(T _p)	245+/-5°C

Appendix 2: Demo Board

The module is equipped with a standard DEMO board for customer to debug the program and test distance. The power supply voltage range: 3.3V~6.0V. It shows as below:

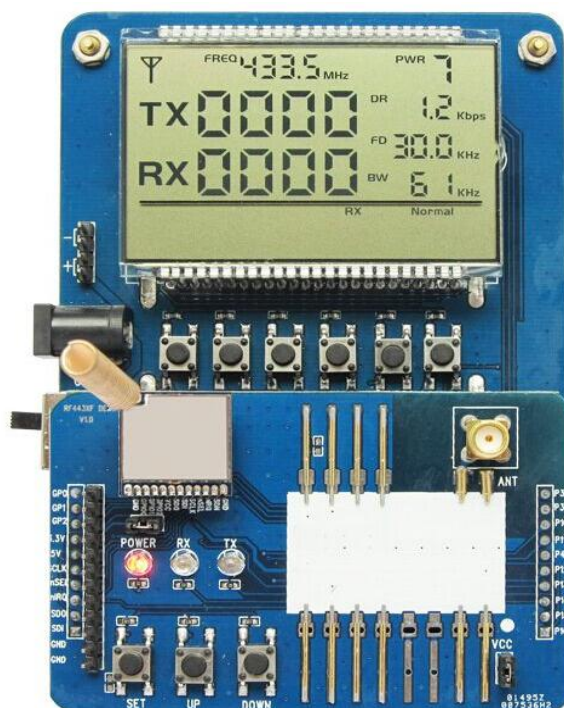

The LCD Full Segment is as below:

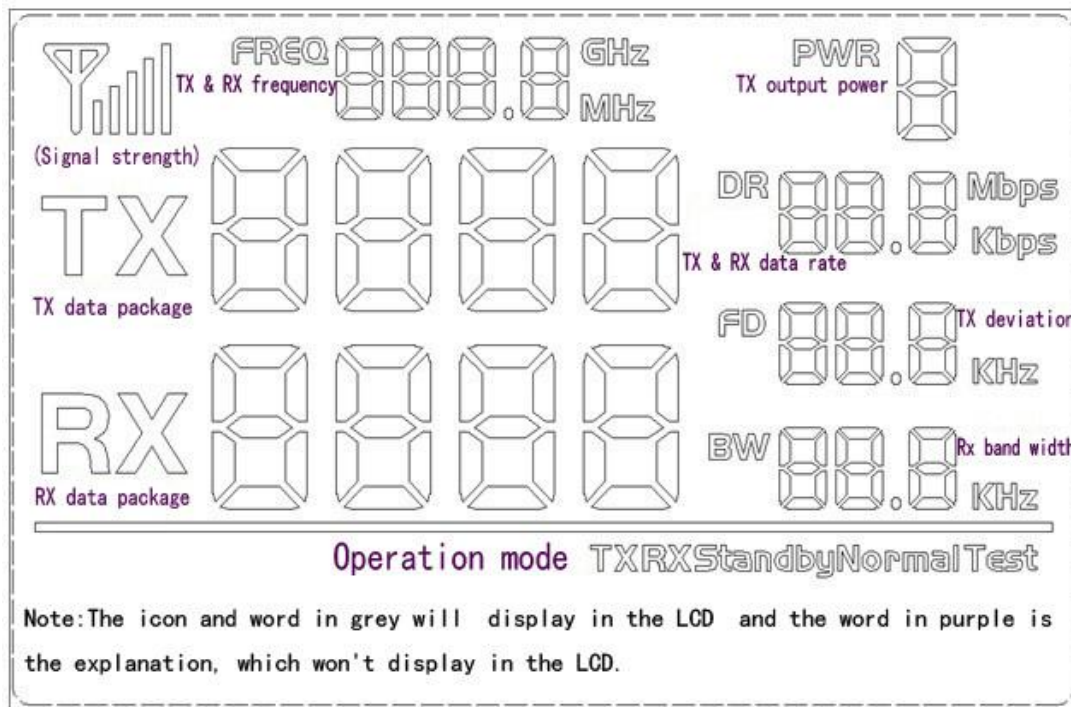

The users can set the parameters of the RF module such as frequency /transmitter power / transmission data rate through the buttons.

➤ Working Mode:

- 1) Tx normal mode: Send data packets regularly (In the setting mode, data packets will not be sent);
- 2) Rx normal mode: Power on and enter the receive state, receive data packets, and then send out the correctly received data packets;
- 3) Tx Test Mode: RF module continuously transmit signal;
- 4) Rx Test Mode: RF module is always in Rx mode;
- 5) Standby Mode: RF module is always in standby state.

➤ Button Operation:

- 1) [SET] Button

Press the key to enter the setting mode. If the last parameter is set, the key will exit the setting mode.

- 2) UP /Down Button

In setting mode, press to modify the corresponding setting parameters.

Note: The DEMO board has FLASH memory inside, all the setting parameters will behave automatically and keep unchanged even power-off.